



— THE —
ASANA

ASANA

noun | asa·na | \ ' ä-sə-nə \

yoga posture / art of sitting still / useful for
restoring and maintaining wellbeing /
improving the body's flexibility and vitality

The Asana.

A privileged space imbuing a sense of tranquility and an atmosphere of serenity.

Derived from a desire to provide the perfect balance between life and lifestyle, these one, two and three-bedroom apartments offer a contemporary urban sanctuary within Singapore's most distinguished neighbourhood.



The clever use of space and light means to come home to The Asana is to truly come home - relax, recharge and rejuvenate in your haven from the outside world.

The apartments have been designed to encourage an aura of harmony within a free-flowing environment. The black and gold colourways, applied boldly to the exterior and subtly to the interior emulate luxury.



COMFORT RELAX LIFESTYLE

BALANCE TRANQUILITY PARADISE

SENSE WELLBEING *a luxurious*

SERENITY NATURE STYLE

contemporary PRIVILEGED

REJUVENATE *urban* RESORT

CHI NAMASTE OHM BESPOKE

SOPHISTICATED *sanctuary*

MAP KEY

LIFESTYLE

- 1 CLUNY COURT
- 2 ADAM ROAD FOOD CENTRE
- 3 CORONATION SHOPPING PLAZA
- 4 THE SINGAPORE ISLAND COUNTRY CLUB (BUKIT LOCATION)
- 5 THE GRANDSTAND (FORMERLY TURF CITY)
- 6 STAR VISTA
- 7 HOLLAND VILLAGE
- 8 DEMPSEY HILL
- 9 TANGLIN MALL
- 10 ION ORCHARD
- 11 SCOTT'S SQUARE
- 12 RAFFLES TOWN CLUB

EDUCATION

- 1 NANYANG PRIMARY SCHOOL (200M)
- 2 RAFFLES GIRLS' PRIMARY SCHOOL (WITHIN 2KM)
- 3 SINGAPORE CHINESE GIRLS' SCHOOL (WITHIN 2KM)
- 4 ANGLO-CHINESE SCHOOL (BARKER ROAD)
- 5 NUS BUKIT TIMAH CAMPUS
- 6 ST MARGARET'S SECONDARY SCHOOL
- 7 HWA CHONG INSTITUTION
- 8 HWA CHONG INTERNATIONAL SCHOOL
- 9 NATIONAL JUNIOR COLLEGE
- 10 NANYANG GIRLS' HIGH SCHOOL
- 11 METHODIST GIRLS' SCHOOL

PARKS

- 1 SINGAPORE BOTANIC GARDENS
- 2 JACOB BALLAS CHILDREN'S GARDEN
- 3 MACRITCHIE RESERVOIR

HEALTHCARE

- 1 GLENEAGLES HOSPITAL
- 2 CAMDEN MEDICAL CENTRE

--- DOWNTOWN LINE

--- CIRCLE LINE

--- THOMSON EAST COAST LINE

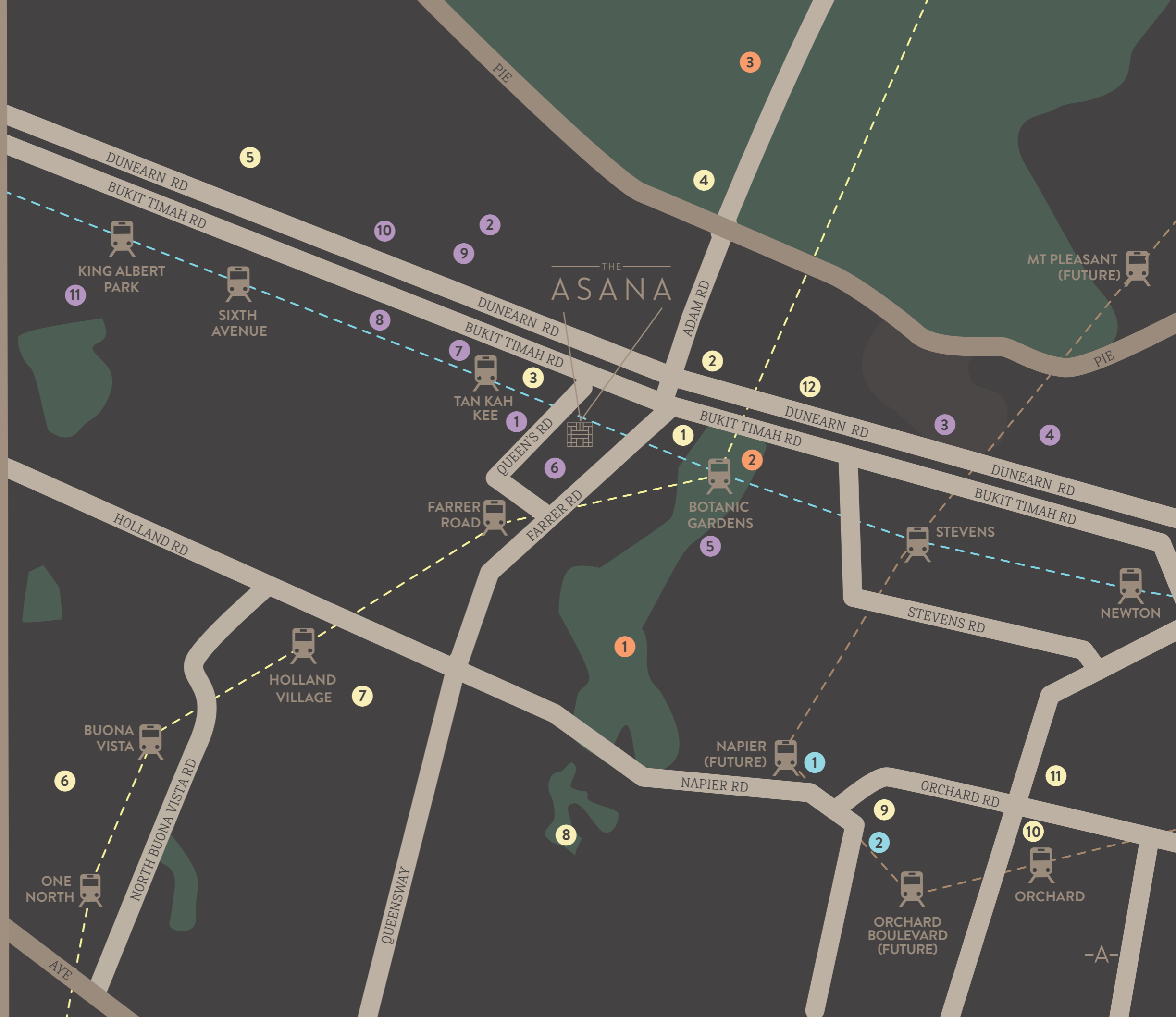

The Asana is truly situated in one of Singapore's most desirable spots, not only is it surrounded by some of the country's most sought after schools but Orchard Road and the City are easily accessible too.

The Botanic Gardens MRT station is just a short walk away, swiftly connecting you with the rest of the island on the Circle and Downtown Lines. The education in the area is simply second to none, with Nanyang Primary School, Raffles Girls' Primary School and Singapore Chinese Girls' School, as well as a host of international schools and junior colleges nearby.

Your neighbour is the world famous Botanic Gardens, recently awarded the prestigious title of a UNESCO world heritage site. Here you can choose between losing yourself in lush greenery, exploring the Jacob Ballas Children's Garden or just soaking up the atmosphere of the Symphony Stage.

For your family's everyday convenience, Cluny Court and Holland Village are close by and you can enjoy the gastro delights at Dempsey Hill, Rochester Park and Greenwood Avenue just further afield.

You are *simply* spoilt for choice.





Meticulously thought out, the landscaping reflects the overall zen ethos, from the grand entrance flanked by lily ponds and ornate screens, to the yoga pavilion and garden of light.



Artist's Impression

Overlooking the lily pond, enjoy a moment of quiet reflection in this exclusive and intimate space.

The entertainment pavilion serves as an atmospheric venue for dinner parties and social gatherings.



You can truly relax and rejuvenate
whilst enjoying The Asana's
first-class facilities.

Utter bliss.



While away hours in the sunken tea garden, which overlooks the garden of light, the perfect place to enjoy an afternoon of leisure.



Absorb the *chi* that flows
throughout the residences as you
perform your daily 'asana'.

Namaste.





Beautifully considered open plan spaces designed with functionality and ease of living in mind. A neutral colour palette is teamed with floor-to-ceiling glazing allowing light to flood through the apartments.

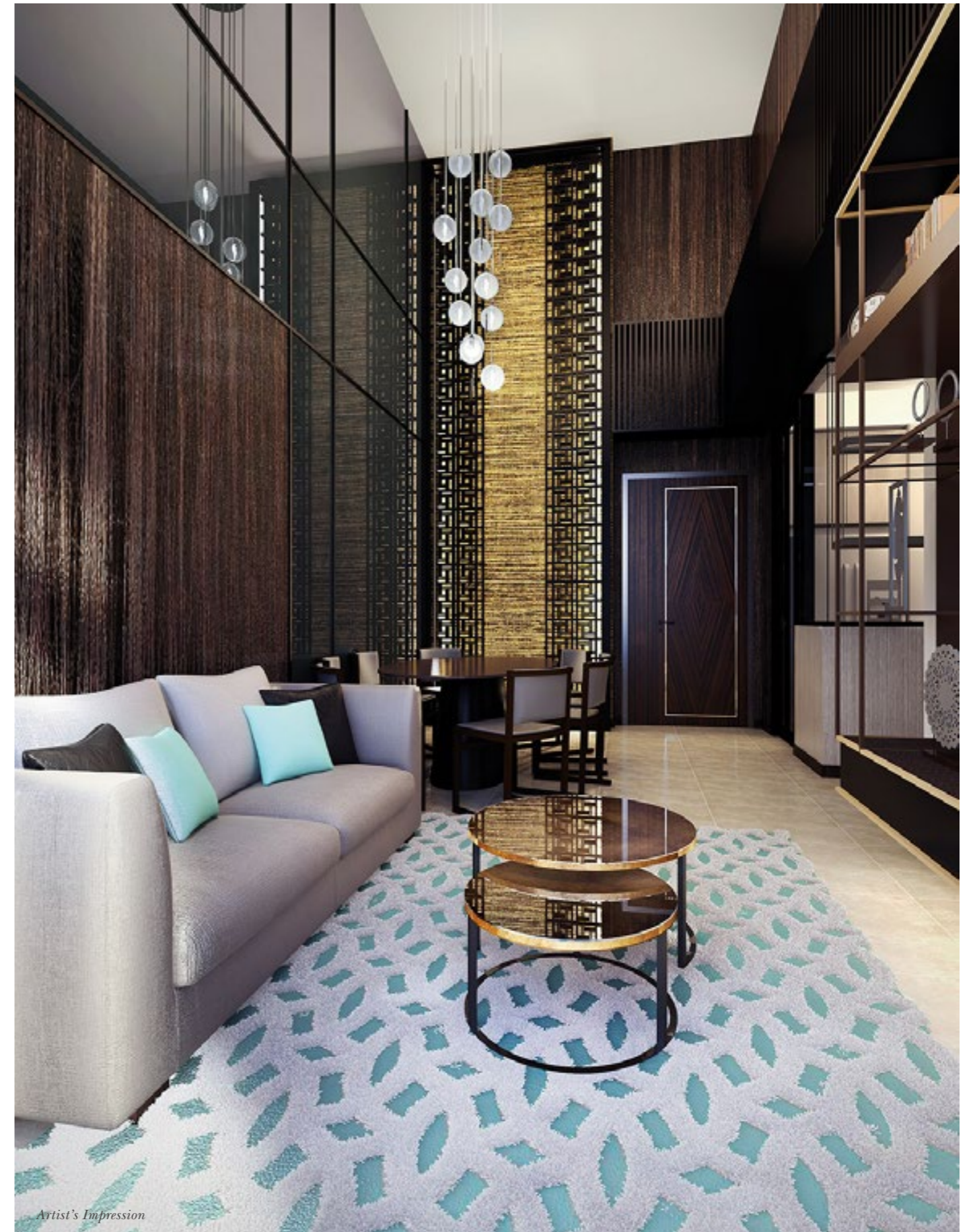

Crafted from the finest materials, the kitchen provides a contemporary setting for lavish living.



The master bedroom is your very own serene retreat offering privacy and escape.



Artist's Impression



Artist's Impression



Artist's Impression

Reflecting the style and sophistication of The Asana, the lofts are as beautiful as they are practical.



Artist's Impression

Awaken your senses in the bathroom, designed with revitalisation in mind. Undeniable opulence.



SITE PLAN

- | | |
|----------------------------|---------------------|
| (A) Drop off Area | (H) Children's Pool |
| (B) Serenity Lounge | (I) Gym |
| (C) Entertainment Pavilion | (J) Yoga Pavilion |
| (D) Sky Garden | (K) Garden of Light |
| (E) Pool | (L) Tea Garden |
| (F) Jacuzzi | (M) Pedestrian Gate |
| (G) Sun Lounges | (N) Guard House |



BLOCK A

17 Queen's Road, 266744



UNIT	01	02	03	04	05
5th STOREY	B2P	B2P	C1P	AP	B3P
4th STOREY	B2	B2	C1	A	B3
3rd STOREY	C2	C2	C1	A	B3
2nd STOREY	B2	B2	C1	A	B3
1st STOREY	C2G			A	B3G

BLOCK B

19 Queen's Road, 266745

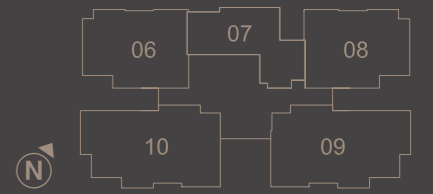

UNIT	06	07	08	09	10
5th STOREY	B3P	B1P	B3P	C2	C2
4th STOREY	B3	B1	B3	B2	B2
3rd STOREY	B3	B1	B3	C2	C2
2nd STOREY	B3	B1	B3	B2	B2
1st STOREY	B3G	B1	B3G	C2G	C2G

- 1 Bedroom Apartments
- 2 Bedroom Apartments
- 3 Bedroom Apartments

TYPE A

37 sq m / 398 sq ft
#01-04 to #04-04

1 BEDROOM

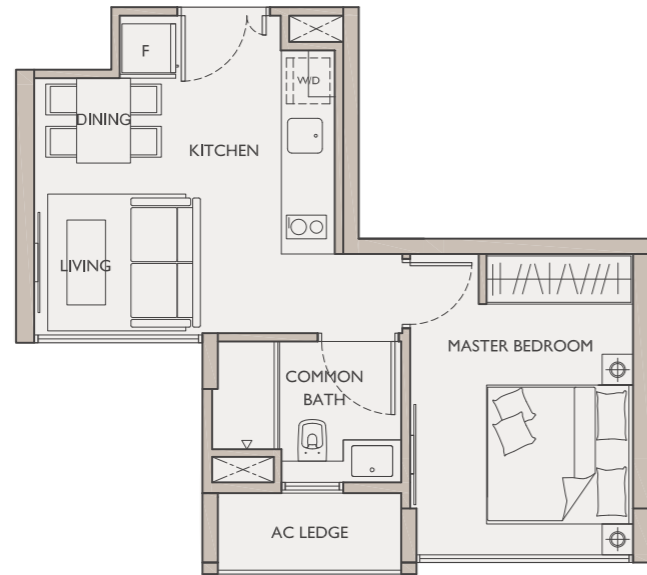

TYPE AP

48 sq m / 517 sq ft
#05-04

1 BEDROOM

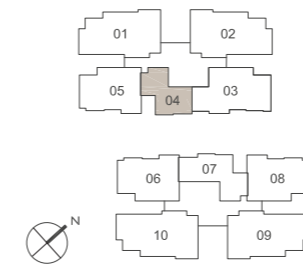
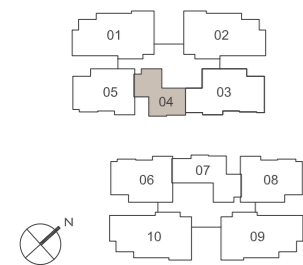

TYPE B1

47 sq m / 506 sq ft
#01-07 to #04-07

2 BEDROOM

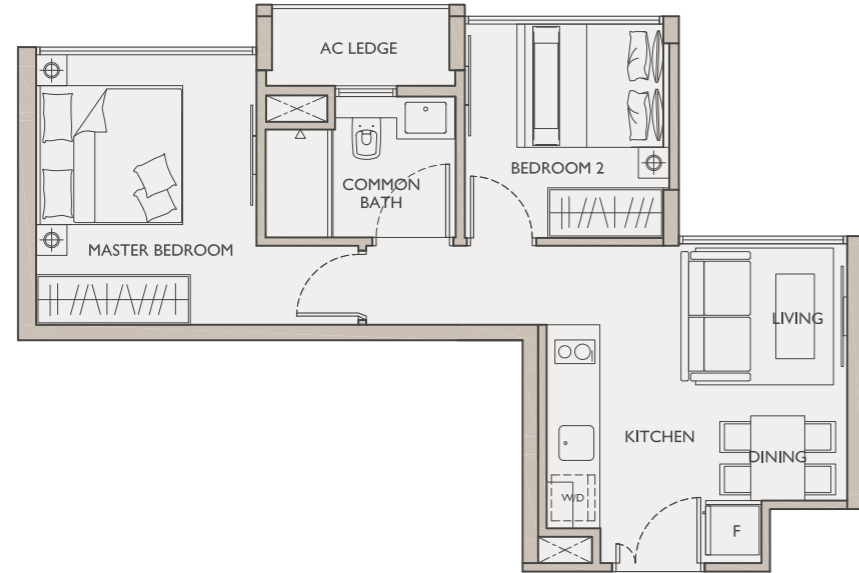

TYPE B1P

58 sq m / 624 sq ft
#05-07

2 BEDROOM

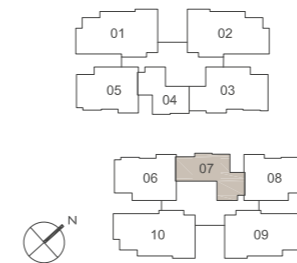
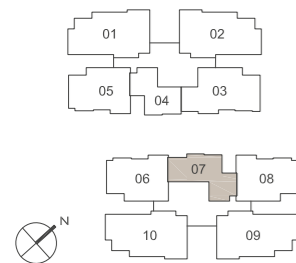
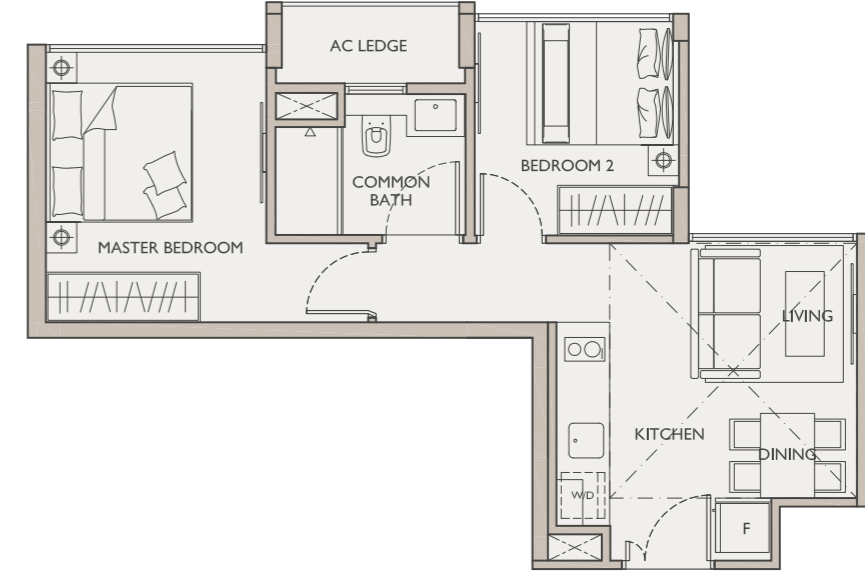

Floor areas are inclusive of PES, balconies, a/c ledges and voids. Floor areas are approximate measurements and subject to final survey. The plans are subject to changes as required or approved by relevant authorities. The balconies shall not be enclosed unless with approved balcony screens.

Floor areas are inclusive of PES, balconies, a/c ledges and voids. Floor areas are approximate measurements and subject to final survey. The plans are subject to changes as required or approved by relevant authorities. The balconies shall not be enclosed unless with approved balcony screens.

TYPE B2

53 sq m / 570 sq ft

#02-01, #04-01

#02-02, #04-02 (mirror)

#02-09, #04-09

#02-10, #04-10 (mirror)

2 BEDROOM

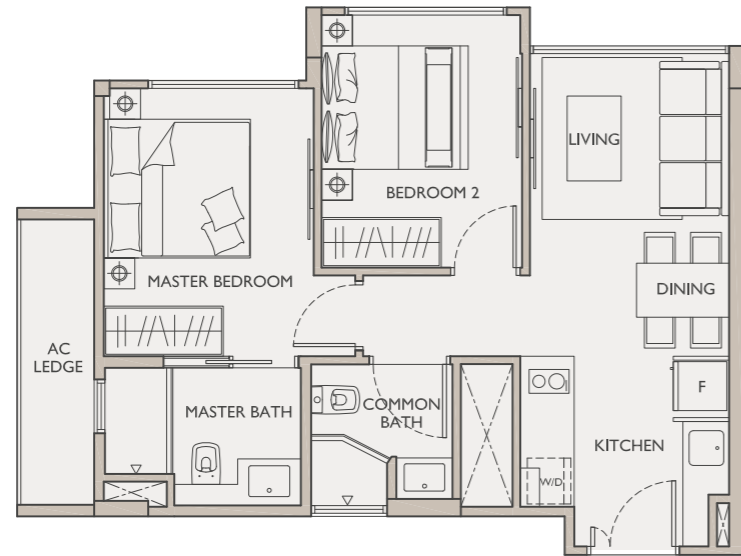

TYPE B2P

63 sq m / 678 sq ft

#05-01

#05-02 (mirror)

2 BEDROOM

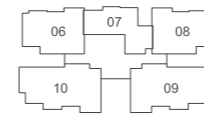
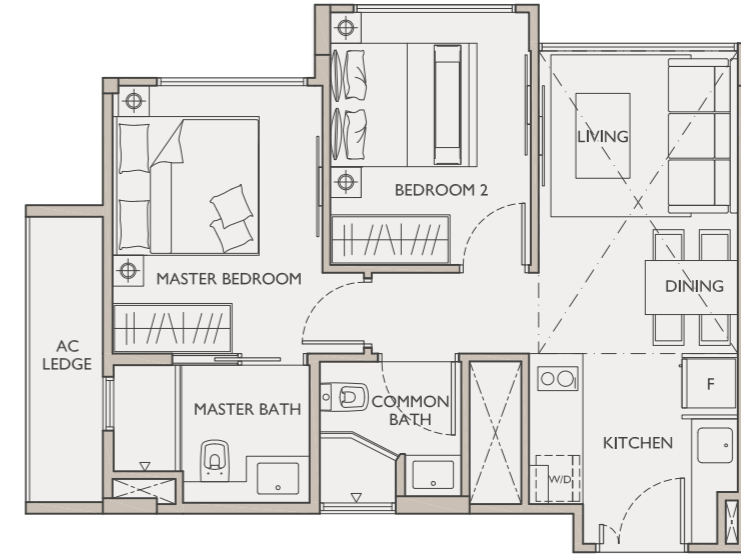

TYPE B3G

59 sq m / 635 sq ft
#01-05 (mirror)
#01-06
#01-08 (mirror)

2 BEDROOM

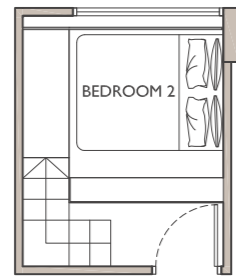
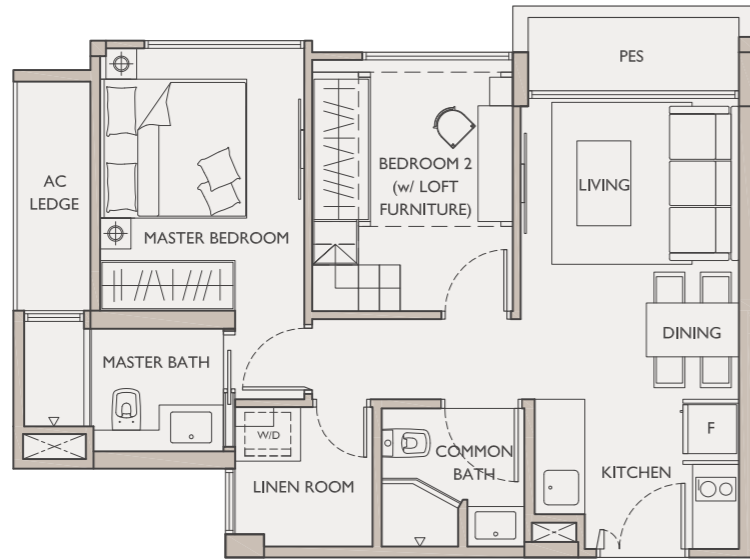

FURNITURE DECK

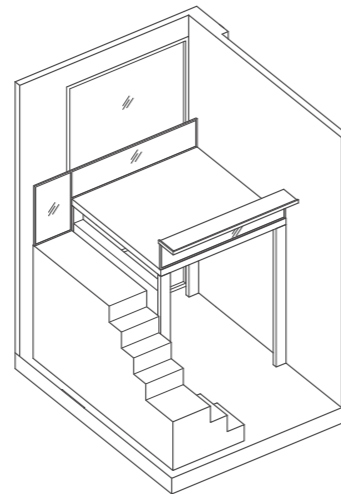

ISOMETRIC VIEW

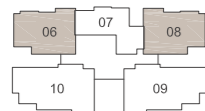

Floor areas are inclusive of PES, balconies, a/c ledges and voids. Floor areas are approximate measurements and subject to final survey. The plans are subject to changes as required or approved by relevant authorities. The balconies shall not be enclosed unless with approved balcony screens.

TYPE B3

59 sq m / 635 sq ft
#02-05 to #04-05 (mirror)
#02-06 to #04-06
#02-08 to #04-08 (mirror)

2 BEDROOM

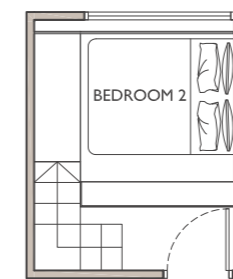
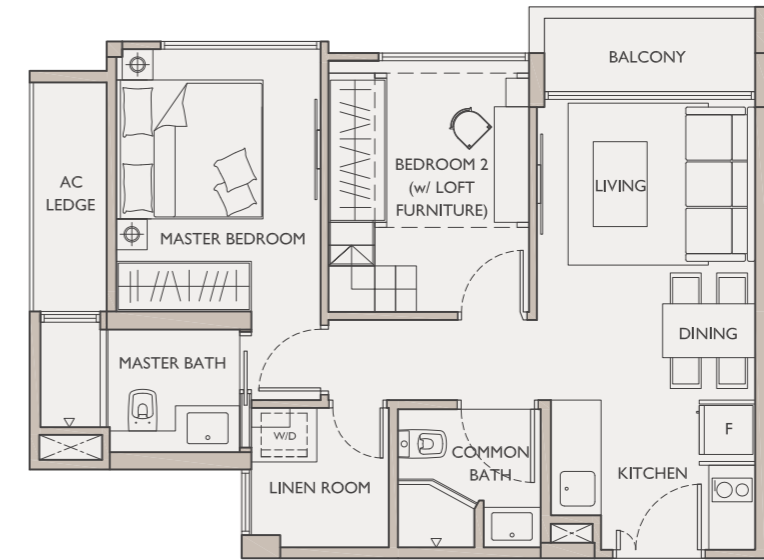

FURNITURE DECK

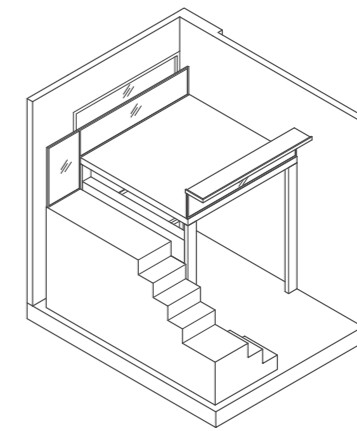

ISOMETRIC VIEW

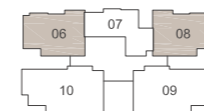

Floor areas are inclusive of PES, balconies, a/c ledges and voids. Floor areas are approximate measurements and subject to final survey. The plans are subject to changes as required or approved by relevant authorities. The balconies shall not be enclosed unless with approved balcony screens.

TYPE B3P

71 sq m / 764 sq ft
#05-05 (mirror)
#05-06
#05-08 (mirror)

2 BEDROOM

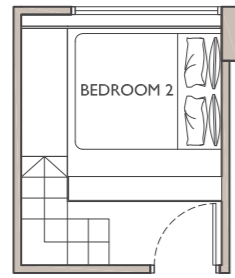
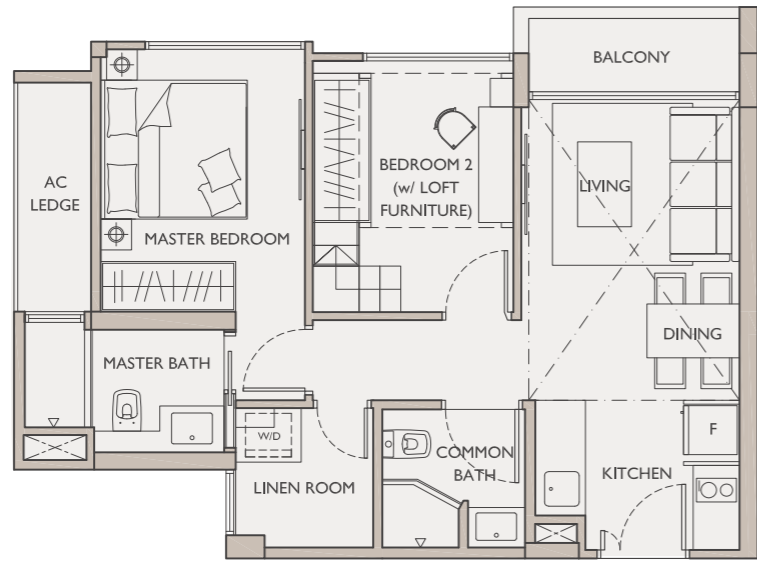

FURNITURE DECK

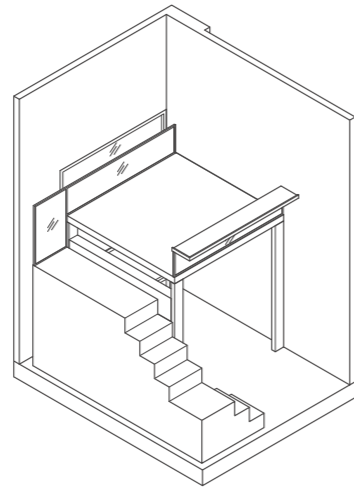

ISOMETRIC VIEW

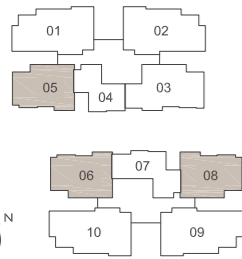

TYPE C1

70 sq m / 753 sq ft
#02-03 to #04-03

3 BEDROOM

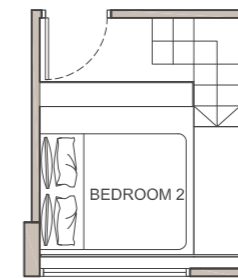
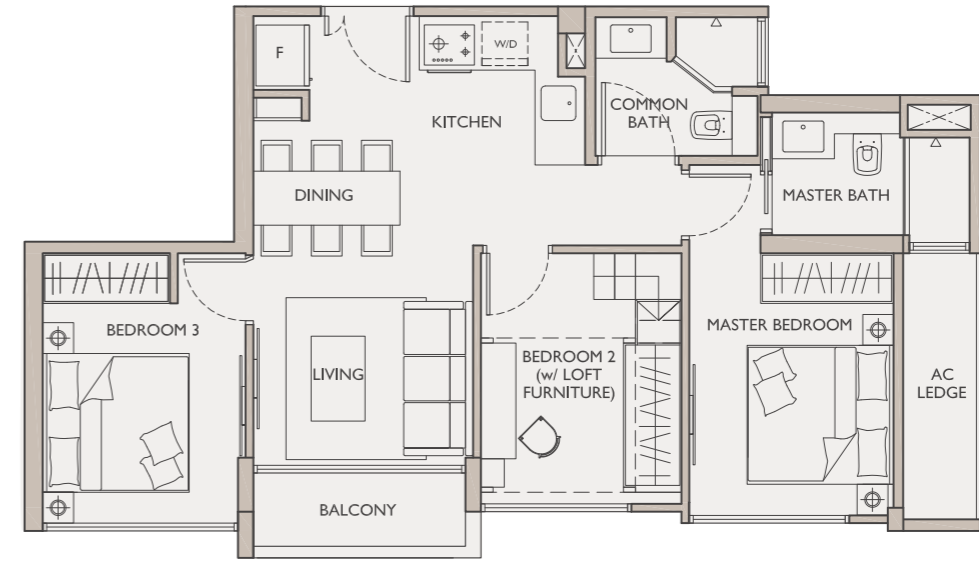

FURNITURE DECK

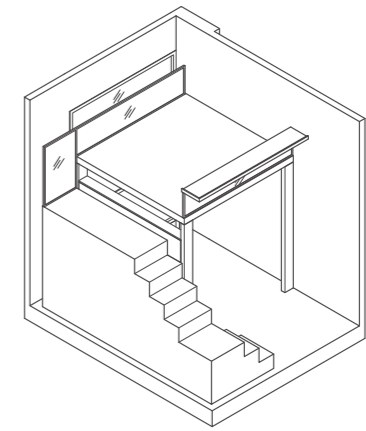

ISOMETRIC VIEW

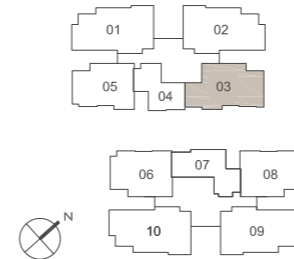

TYPE C1P

78 sq m / 840 sq ft
#05-03

3 BEDROOM

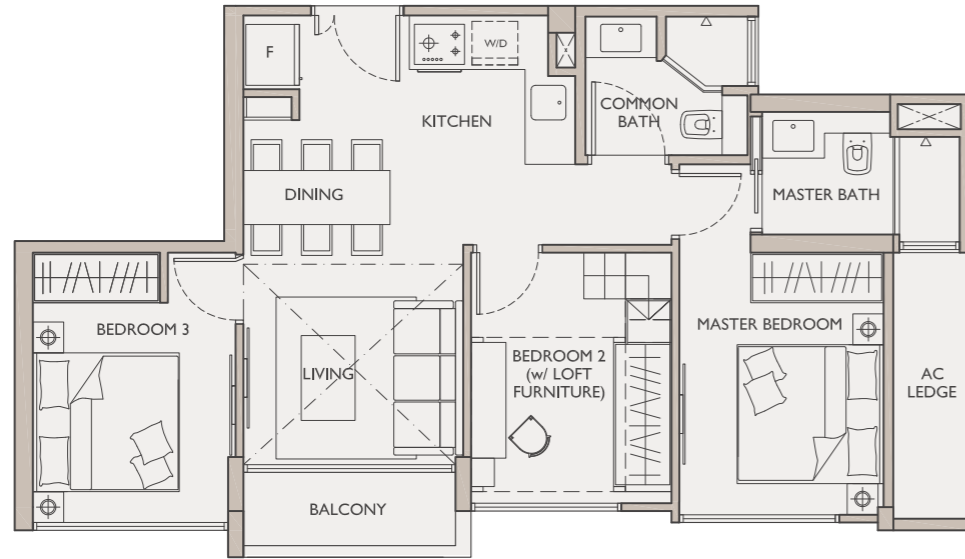

FURNITURE DECK

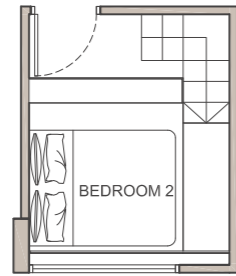

ISOMETRIC VIEW

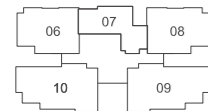
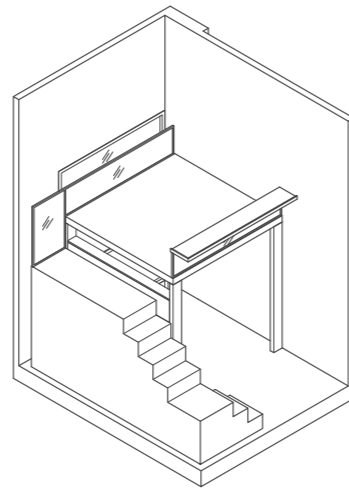

Floor areas are inclusive of PES, balconies, a/c ledges and voids. Floor areas are approximate measurements and subject to final survey. The plans are subject to changes as required or approved by relevant authorities. The balconies shall not be enclosed unless with approved balcony screens.

TYPE C2G

99 sq m / 1,066 sq ft
#01-01

3 BEDROOM

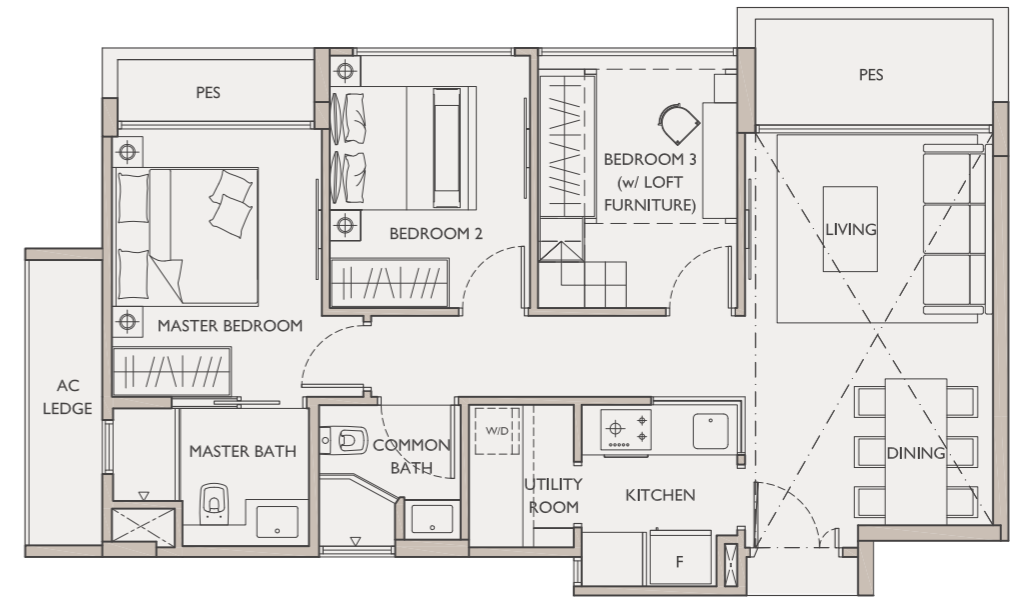

FURNITURE DECK



ISOMETRIC VIEW

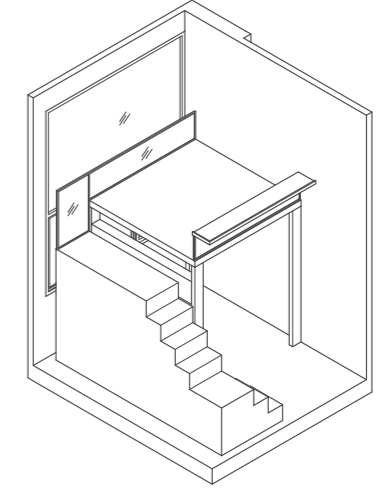

Floor areas are inclusive of PES, balconies, a/c ledges and voids. Floor areas are approximate measurements and subject to final survey. The plans are subject to changes as required or approved by relevant authorities. The balconies shall not be enclosed unless with approved balcony screens.

TYPE C2G
100 sq m / 1,076 sq ft
#01-09

3 BEDROOM

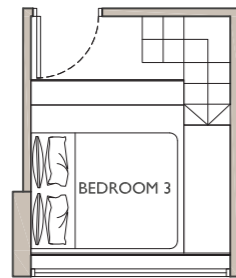
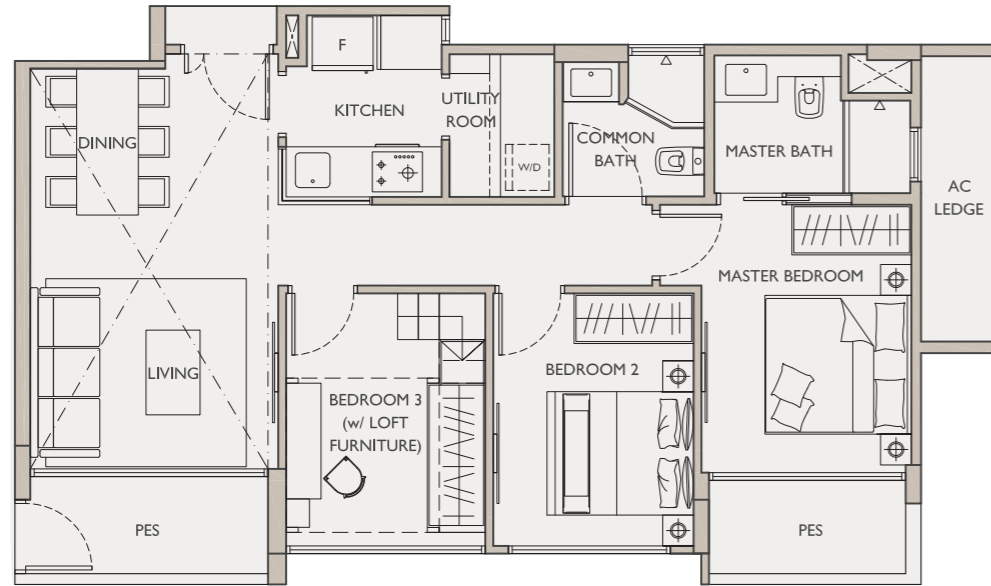

FURNITURE DECK

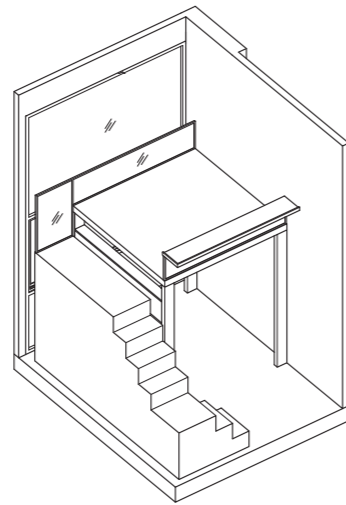

ISOMETRIC VIEW

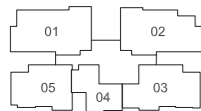

Floor areas are inclusive of PES, balconies, a/c ledges and voids. Floor areas are approximate measurements and subject to final survey. The plans are subject to changes as required or approved by relevant authorities. The balconies shall not be enclosed unless with approved balcony screens.

TYPE C2G
99 sq m / 1,066 sq ft
#01-10

3 BEDROOM

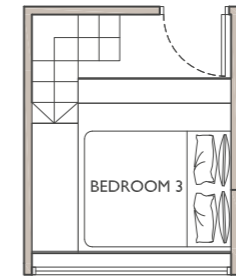
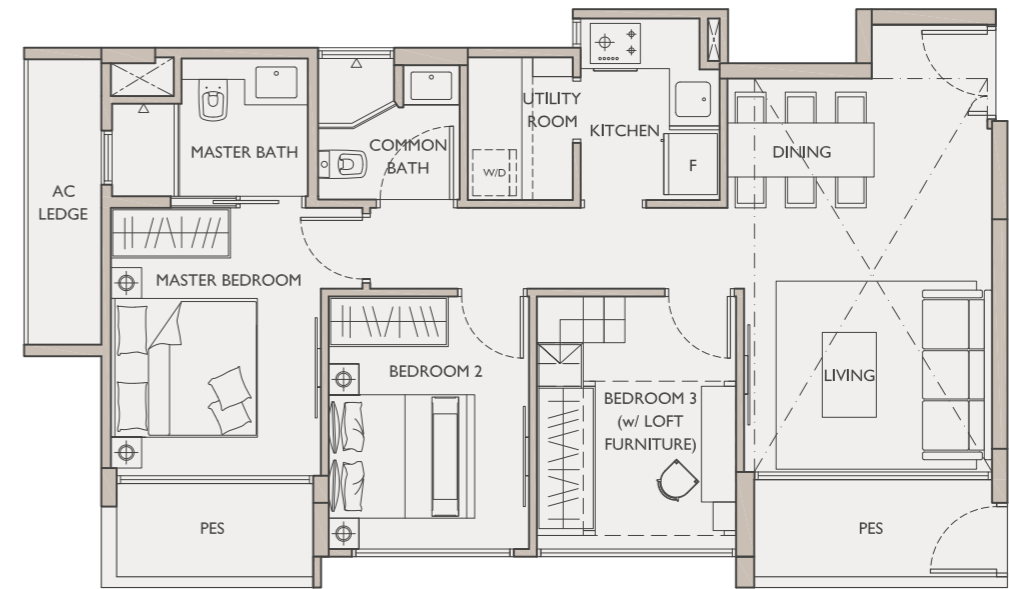

FURNITURE DECK

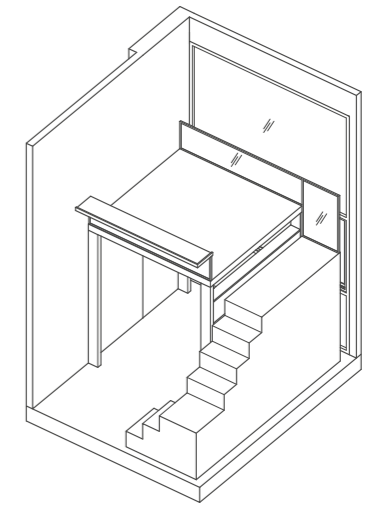

ISOMETRIC VIEW



Floor areas are inclusive of PES, balconies, a/c ledges and voids. Floor areas are approximate measurements and subject to final survey. The plans are subject to changes as required or approved by relevant authorities. The balconies shall not be enclosed unless with approved balcony screens.

TYPE C2

96 sq m / 1,033 sq ft

#03-01

#03-02 (mirror)

#03-09 & #05-09

#03-10 & #05-10 (mirror)

3 BEDROOM

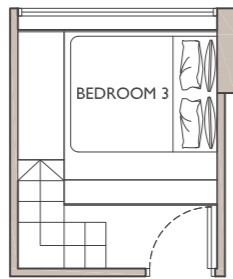
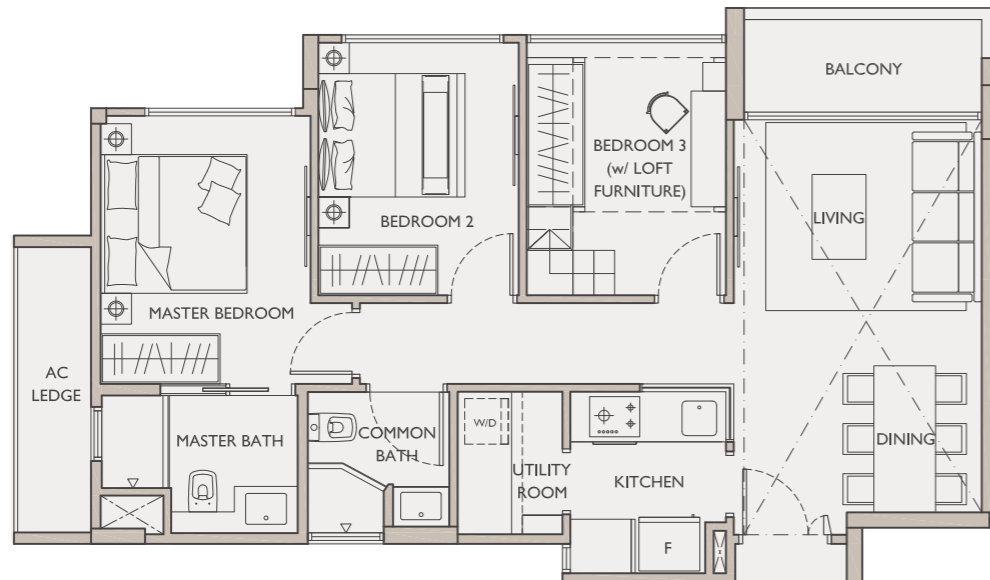

FURNITURE DECK

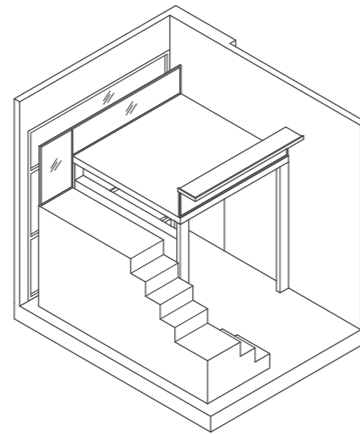

ISOMETRIC VIEW

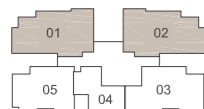

Floor areas are inclusive of PES, balconies, a/c ledges and voids. Floor areas are approximate measurements and subject to final survey. The plans are subject to changes as required or approved by relevant authorities. The balconies shall not be enclosed unless with approved balcony screens.

1. FOUNDATION

Reinforced concrete footing and/or precast concrete piles and/or reinforced concrete bored piles.

2. SUPERSTRUCTURE

Reinforced concrete structure.

3. WALLS

- External Wall: Precast concrete, brick walls, aerated lightweight concrete blocks and/or reinforced concrete.
- Internal Wall: Drywall partitions, brick walls, precast concrete panels, aerated lightweight concrete blocks and/or reinforced concrete.

4. ROOF

- Pitched Roof: Metal Roofing over reinforced concrete or steel structure, with appropriate insulation and waterproofing system.
- Flat Roof: Reinforced Concrete Flat Roof with appropriate insulation and waterproofing system.

5. CEILING

- Fibrous plasterboard ceiling with emulsion paint for Bathrooms, Corridors, Kitchens, Foyers and Utility Rooms (where applicable).
- Reinforced concrete soffit skim-coated with emulsion paint generally and gypsum plasterboard ceiling with emulsion paint where applicable for other areas.

Refer to Ceiling Height (M) Schedule on page 57

6. FINISHES

WALLS: APARTMENTS

- Stones and/or ceramic and/or homogeneous tiles up to false ceiling level (no tiles behind cabinets and mirrors) for Bathrooms.
- Ceramic and/or homogeneous tiles up to false ceiling level (no tiles behind cabinets) and/or plaster and/or skim coat with emulsion paint for Kitchens (where applicable).
- Plaster and/or skim coat with emulsion paint to other areas.

WALLS: COMMON AREAS

- Plaster and/or skim coat with emulsion paint and/or reinforced concrete finish (where applicable).
- Plaster and/or skim coat with emulsion paint and/or mirror where applicable to Gym.
- Stones and/or homogeneous tiles and/or plaster/

skim coat with emulsion paint to 1st storey Lift Lobbies and basement Lift Lobbies.

- Homogeneous tiles and/or mosaic and/or plaster/skim coat with emulsion paint to typical Lift Lobbies, Entertainment Pavilion, Toilets, Management Office and Guard House.
- Artificial green wall and/or stones and/or homogeneous tiles and/or plaster and/or skim coat with emulsion paint to Sky Gardens.

FLOORS: APARTMENTS

- Marble to Living, Dining, Corridors and Open Kitchens (where applicable).
- Timber strip flooring to Bedrooms (where applicable).
- Stones and/or ceramic and/or homogeneous tiles to Bathrooms, Enclosed Kitchens, Balconies, Utility Rooms, Linen Rooms and PES (where applicable).

FLOORS: COMMON AREAS

- Stones and/or homogeneous tiles and/or ceramic tiles to all Lift Lobbies.
- Stones and/or mosaic and/or homogeneous tiles and/or EPDM rubber flooring to Swimming Pool, Jacuzzi and Kid's Pool.
- Timber decking and/or composite timber decking and/or stones and/or homogeneous tiles to Pool Deck, Entertainment Pavilion, Serenity Lounge, Yoga Pavilion, Tea Garden, Sky Gardens, Management Office and Guard House.
- Stones and/or mosaic and/or homogeneous tiles to Ponds and Water Features.
- Carpet and/or homogeneous tiles and/or laminate flooring and/or vinyl flooring and/or EPDM rubber flooring to Gym.
- Stones and/or ceramic and/or homogeneous tiles to Toilets.

7. WINDOWS

Powder coated and/or anodized aluminium framed windows with minimum 6mm thick tinted/clear/frosted and/or float/laminated/tempered glass (where appropriate).

8. DOORS

- Approved fire-rated timber doors and frames to Main Entrances.
- Timber doors and frames to all internal rooms (where applicable).
- Powder-coated and/or anodized aluminium framed sliding glass doors with tinted/clear/frosted and/or float/laminated/tempered glass to Balconies and PES (where applicable).
- Good quality ironmongery.

9. SANITARY FITTINGS

MASTER BATH AND COMMON BATH:

- 1 set glass partitioned shower cubicle, shower mixer and shower handset c/w shower bar and hose.
- 1 no. pedestal water closet with seat and cover or wall hung water closet with seat and cover c/w concealed cistern (where applicable).
- 1 no. basin c/w tap mixer, bottle trap and vanity counter.
- 1 paper holder.
- 1 towel rail.

10. ELECTRICAL INSTALLATION

Refer to Electrical Schedule for details.

11. TV/CABLE SERVICES/FM/TELEPHONE POINTS

Refer to Electrical Schedule for details.

12. LIGHTNING PROTECTION

Lightning Protection System shall be provided in accordance with Singapore Standard.

13. PAINTING

Refer to Finishes - Walls.

14. WATER PROOFING

Waterproofing to floors of Bathrooms, Kitchens, Balconies, PES, Utility Rooms, Linen Rooms, Reinforced Concrete Flat Roof, Swimming Pool and Kid's Pool, Toilets, Serenity Lounge, Entertainment Pavilion, Yoga Pavilion, Garden of Light, Tea Garden, Sky Gardens, Pond and Water Features.

15. DRIVEWAY AND CAR PARK

- Surface driveway: heavy-duty granite and/or tiles and/or reinforced concrete slab with hardener and/or epoxy coating.
- Ramp and car park: reinforced concrete slab with hardener and/or epoxy coating.

Note: There are exposed M&E service pipes / valve / trunking / ducting / at the carpark and plant rooms.

16. RECREATION FACILITIES

SWIMMING POOL	25.0m (L) x 3.7m (W)
JACUZZI	3.0m (L) x 3.5m (W)
KID'S POOL	4.7m (L) x -3.9m (W)
GYM	3.8m (L) x -2.7m (W)
ENTERTAINMENT PAVILION	3.1m – 6.4m (L) x 4.0m – 7.6m (W)
SERENITY LOUNGE	4.0m (L) x 3.2m (W)
YOGA PAVILION	2.3m (L) x 4.5m (W)
TEA GARDEN	2.5m (L) x 1.2m (W)
SKY GARDEN	6.7m (L) x 4.4m – 6.0m (W)

17. ADDITIONAL ITEMS

- High and low kitchen cabinets in laminate/ veneer/ spray-paint finish complete with electrical cooker hob, cooker hood, microwave combi oven, kitchen sink and washing machine cum dryer (where applicable).
- High and low utility/ linen room cabinets in laminate/ veneer/ spray-paint finish complete with washing machine cum dryer (where applicable).
- Carcass system wardrobe with internal drawers to Bedrooms (where applicable).
- Wall hung split unit and/or cassette air-conditioning to Living, Dining, Kitchens, Linen Rooms and Bedrooms (where applicable).
- Furniture deck in laminate/ veneer/ spray-paint finish to Bedrooms (where applicable).
- Audio intercom system to all units for communication to Pedestrian Entrances and Guard House.
- Vehicle barrier system at main driveway entrance.
- Security surveillance cameras at selected locations of 1st storey common areas and basement.
- Wall hung split unit / ducted/ cassette air-conditioning system to Gym and Entertainment Pavilion.

Note: No alterations or additions should be made to the furniture deck. The maximum weight limit for the furniture deck is 360kg evenly distributed.

ELECTRICAL SCHEDULE (PER UNIT)

	TYPE OF UNIT							
	A	B1	B2	B3	C1	C2	B3G	C2G
Lighting Point	5	7	7	10	9	18	12	22
13A Weatherproof Power Point	0	0	0	1	1	1	1	2
13A Twin Power Point	7	10	11	12	14	16	12	16
Telephone Point	1	1	1	1	1	1	1	1
Data Point	2	2	2	3	3	3	3	3
TV Point	2	2	2	3	3	3	3	3
Cooker Hob Point	1	1	1	1	1	1	1	1
Cooker Hood Point	1	1	1	1	1	1	1	1
Microwave Combi Oven Point	1	1	1	1	1	1	1	1
Fridge Freezer Point	1	1	1	1	1	1	1	1
Power Point for Washing Machine	1	1	1	1	1	1	1	1
Water Heater Point	1	1	2	2	2	2	2	2
Bell Point	1	1	1	1	1	1	1	1

GENERAL DESCRIPTION OF HOUSING PROJECT

Residential building comprising 48 units of apartments with basement carpark, common facilities and swimming pool on Lots 01876X, 01877L, 01878C, 01844N Mukim 02 at 17 and 19 Queen's Road (Bukit Timah Planning Area).

Total number of units in each class:
1-Bedroom Apartments: 5 units
2-Bedroom Apartments: 30 units
3-Bedroom Apartments: 13 units

Description of common property:

48 car park lots and 1 handicapped car park lot in the basement. Management Office, Toilet, Electrical Substation, MDF room, Consumer Switch Room, Hosereel Tank, Hosereel Pump Sets and Hosereels, Domestic Water Tank and Booster Pumps, Rain Water Detention Tank and Ejector Pump Room, PV panels and equipment, Generator, Refuse Chambers, Guard House, Sheltered Bin Point, Filtration Plant Pump Room, Pool Balancing Tank, Electrical Ducts, Telecom Ducts, Water Ducts, Lifts, Lift Lobbies, Staircases and Storey Shelters, Swimming Pool, Jacuzzi, Kid's Pool, Gym, Entertainment Pavilion, Serenity Lounge, Yoga Pavilion, Tea Garden, Landscaped Area, Handicap Toilet, pond and water features and all other common property as defined in the Building and Common Property (Maintenance and Management) Act, Cap. 30 and Land Titles (Strata) Act, Cap 158.

Total number of car parking spaces:
Sufficient carpark lots provided as may be approved by the relevant authorities.

Purpose of Housing Project and restrictions as to use:
Residential.

CEILING HEIGHT (M) SCHEDULE

1ST STOREY	TYPE OF UNIT				
	A	B1	B3G	C2G (#01-10)	C2G (#01-01) & (#01-09)
Foyer	-	-	-	-	3.0
Dining	4.2	4.2	4.2	5.5/3.1	5.5
Living	4.2	4.2	4.2	5.5	5.5
Kitchen (open)	3.1	3.1	3.1	-	-
Kitchen (enclosed)	-	-	-	3.1	3.1
Corridor	3.1	3.1	3.1	3.1	3.1
Master Bedroom	4.2/3.1	4.2/3.1	4.2/3.1	4.2/3.1	4.2/3.1
Bedroom 2	-	4.2/3.1	4.2	4.2/3.1	4.2/3.1
Bedroom 3	-	-	-	4.2	4.2
Master Bath	-	-	3.1	3.1	3.1
Bath 2	3.1	3.1	3.1	3.1	3.1
Linen Room	-	-	3.6	-	-
Utility Room	-	-	-	4.2	4.2
PES	-	-	4.3	5.5/4.3	5.5/4.3

TYPICAL STOREY	TYPE OF UNIT					
	A	B1	B2	B3	C1	C2
Foyer	-	-	-	-	-	2.7
Dining	3.2	3.2	3.2	3.2	3.2	5.5
Living	3.2	3.2	3.2	3.2	3.2	5.5
Kitchen (open)	2.7	2.7	2.7	2.7	2.7	-
Kitchen (enclosed)	-	-	-	-	-	2.8
Corridor	2.7	2.7	2.7	2.7	2.7	2.7
Master Bedroom	3.2/2.7	3.2/2.7	3.2/2.7	3.2/2.7	3.2/2.7	3.2/2.7
Bedroom 2	-	3.2/2.7	3.2/2.7	3.2	3.2	3.2/2.7
Bedroom 3	-	-	-	-	3.2/2.7	3.2
Master Bath	-	-	2.7	2.7	2.7	2.7
Bath 2	2.7	2.7	2.7	2.7	2.7	2.7
Linen Room	-	-	-	3.2	-	-
Utility Room	-	-	-	-	-	3.2
Balcony	-	-	-	3.2	3.2	5.5

5TH STOREY	TYPE OF UNIT					
	A	B1	B2	B3	C1	C2
Foyer	-	-	-	-	-	2.7
Dining	5.2	5.2	5.2	5.2	2.8	5.5
Living	5.2	5.2	5.2	5.2	5.2	5.5
Kitchen (open)	2.8	2.8	2.8	2.8	2.8	-
Kitchen (enclosed)	-	-	-	-	-	2.8
Corridor	2.8	2.8	2.8	2.8	2.8	2.8
Master Bedroom	3.6/2.8	3.6/2.8	3.6/2.8	3.6/2.8	3.6/2.8	3.6/2.8
Bedroom 2	-	3.6/2.8	3.6/2.8	4.5	4.5	3.6/2.8
Bedroom 3	-	-	-	-	3.6/2.8	4.5
Master Bath	-	-	2.8	2.8	2.8	2.8
Bath 2	2.8	2.8	2.8	2.8	2.8	2.8
Linen Room	-	-	-	3.6	-	-
Utility Room	-	-	-	-	-	4.2
Balcony	-	-	-	3.4	3.4	5.5



AURUM LAND PTE LTD

BEST BOUTIQUE DEVELOPER SINGAPORE 2015

Aurum Land, winner of the Best Boutique Developer Singapore 2015, was incorporated in 1982 and is a wholly owned subsidiary of Woh Hup holdings Pte Ltd.

Aurum Land's projects are managed by a team of highly competent industry professionals, bringing together over 50 years of development expertise, design excellence, technical skill and market insight. Being an integrated property developer focused on the residential market, Aurum Land is committed to delivering high quality homes with meticulous attention to detail that combine the best in functionality and form.

Recent awards include: The Best Apartment Singapore 2015 for Three 11, The Best Apartment Asia Pacific and The Best Apartment in the World 2014 and the Silver Residential I-DEA award 2012 for 1919 The Black and White Residences.

WOH HUP PTE LTD

Founded in 1927, Woh Hup is Singapore's leading construction and civil engineering specialist, recognised for shaping the landscape with high quality, innovative building solutions. Woh Hup has a dedicated workforce of 1,000 personnel, and a body of work spanning many of Singapore's most notable and iconic developments including Jewel Changi Airport, Clifford Pier, Gardens by the Bay, Reflections at Keppel Bay, The Interlace and Tate Residences. Over the years, Woh Hup has been involved in numerous residential, commercial, institutional and civil engineering projects.

PARK + ASSOCIATES PTE LTD

Park + Associates seeks to create coherent spaces where function and beauty speak a common language. The firm's strategy is one of subtraction and control to preserve the necessary simplicity of spaces. Each project is undertaken with a rigorous eye for detail, placement and materials, with an artistic sensitivity to the "intangibles" of light, space and form. Charting a journey for the user in a unique space; creating sophisticated spaces that inspire, invigorate, and refine the senses – that is what Park + Associates sets out to achieve.

Park + Associates was recently honoured Design of the Year at The President's Design Award 2015, the highest design accolade in Singapore for practitioners in the design industry.

2ND EDITION PTE LTD

Established in July 2005, 2nd edition began as a boutique interior design studio. They believe strongly in building long lasting client relationships, offering a design vision with sensitive emphasis on the need to create excellent as well as unique and distinctive solutions in response to their clients' briefs.

Their design process strives to express a harmonious balance of authenticity, style and functionality in design statements of subtlety or boldness whilst preserving its essence. 2nd edition aims to deliver elegantly conceptualised end products where beauty and purity are discovered.





While reasonable care has been taken in the preparation of the brochure, the specifications and the attached plans, the developer and its agents shall not be held responsible for any inaccuracies or omissions. All statements, specifications and plans in the brochure are believed to be correct at the time of publication but shall not be regarded as statements or representations of fact. Photographs and images contained in the brochure

do not necessarily represent as built standard specifications.

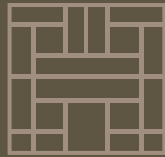

WWW.AURUMLAND.COM/THEASANA



AURUM LAND (PRIVATE) LIMITED
A Subsidiary of Woh Hup Holdings Private Limited